

TEREX RT 400 SERIES

rough terrain cranes
specifications

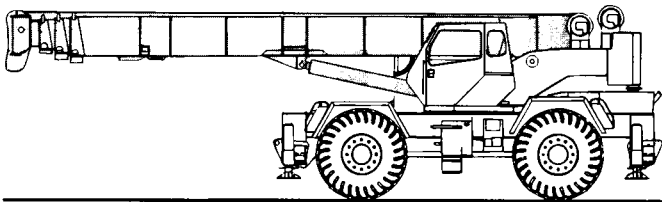

STANDARD BOOM EQUIPMENT

BOOM

33-105 ft. (10.06-32.00 m), four section full power boom. Telescoping is fully synchronized with single lever control. High-strength, four plate construction with side plate holes providing reduced weight. Anti-friction slide pads. Single boom hoist cylinder.

BOOM HEAD

Welded to fourth section of boom. Four or five load sheaves and two idler sheaves mounted on heavy duty, anti-friction bearings. Quick reeving boom head eliminates need to remove wedge and socket from rope. Provision made for side-stow jib mounting.

OPTIONAL BOOM EQUIPMENT

JIBS

33 ft. (10.06 m) side stow swing-on piece lattice type jib. Single sheave mounted on anti-friction bearing. Jib is offsettable at 0°, 15°, or 30°. Maximum tip height is 142 ft. (43.3 m).

33-58 ft. (10.06-17.68 m) side stow swing-on lattice type jib. Single sheave mounted on anti-friction bearing. Jib is extendible to 58 ft. (17.68 m) by means of a 25 ft. (7.62 m) manual pull-out tip section, roller supported for ease of extension. Jib is offsettable at 0°, 15°, or 30°. Maximum tip height is 167 ft. (50.9 m).

AUXILIARY BOOM HEAD

Removable auxiliary boom head has single sheave mounted on anti-friction bearing. Removable pin-type rope guard for quick reeving. Installs on main boom peak only.

HOOK BLOCK

Three, four or five sheaves and locking type hook latch. Quick reeving design does not require removal of wedge and socket from rope.

HOOK & BALL

7.0 ton (6.3 mt) top swivel ball with hook and hook latch.

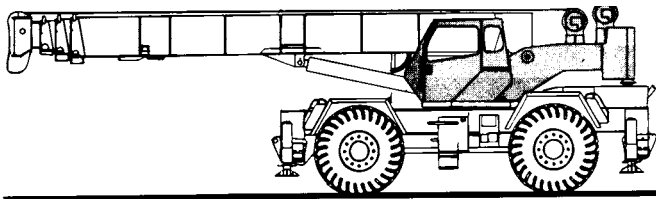

STANDARD UPPERSTRUCTURE EQUIPMENT

UPPERSTRUCTURE FRAME

All welded one-piece structure fabricated with high tensile strength alloy steel. Counterweight is bolted to frame.

TURNTABLE CONNECTION

Swing bearing is single row, ball-type, with internal teeth. The swing gear is bolted to revolving upperstructure and to carrier frame.

SWING

A hydraulic motor drives a double planetary reduction gear for precise and smooth swing function. Swing speed (no load) is 2.5 rpm.

SWING BRAKE

Heavy duty multiple disc swing brake is mechanically actuated from operator's cab by foot pedal. Brake may be locked on or used as a momentary brake. A separate 2-position mechanical house lock is also provided.

RATED CAPACITY INDICATOR

Rated Capacity Indicator with visual and audible warning system and automatic function disconnects. Pictographic display includes: boom radius, boom angle, boom length, allowable load, actual load, and percentage of allowable load registered by bar graph. Operator settable alarms provided for swing angle, boom length, boom angle, tip height, and work area exclusion zone. Anti-two block system includes audio/visual warning and automatic function disconnects.

OPERATOR'S CAB

Environmental cab with all steel construction, optimized visibility, tinted safety glass throughout, and rubber floor matting is mounted on vibration absorbing pads. The cab has a sliding door on the left side, framed sliding window on the right side, hinged tinted glass skylight and removable front windshield to provide

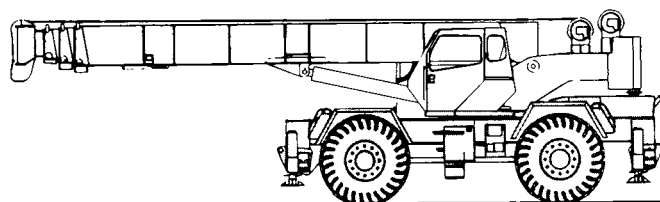

STANDARD CARRIER EQUIPMENT

CARRIER CHASSIS

Chassis is designed and built with four-wheel drive and four-wheel steer (4x4x4). Has box beam type construction with reinforcing cross members, a precision machined turntable mounting plate and integrally welded outrigger boxes. Decking has anti-skid surfaces, including tool storage compartment and access ladders left and right side and front and rear corners.

AXLES AND SUSPENSION

Rear axle is a planetary drive/steer type with automatic oscillation lockouts that engage when the superstructure is swung 10° in either direction. Front axle is a planetary drive/steer type, rigid mounted to the frame for increased stability.

optimized visibility of the load open or closed. Acoustical foam padding insulates against sound and weather. The deluxe six-way adjustable operator's seat is equipped with a torsion bar suspension and includes head and arm rests.

CONTROLS

All control levers and pedals are positioned for efficient operation. Hand-operated control levers include swing, boom telescope, boom hoist, single lever two-speed main winch, shift, vernier adjustable hand throttle and two position house lock. Switches include ignition, engine stop, steering mode, parking brake, and outrigger controls. Foot control pedals include swing brake, boom raise, boom lower, service brake and accelerator.

INSTRUMENTATION AND ACCESSORIES

In-cab gauges include air pressure, bubble level, engine oil pressure, fuel, engine temperature, voltmeter, transmission temperature, and transmission oil pressure. Indicators include low air, high water temperature/low oil pressure/high transmission temperature audio/visual warning, low coolant audio/visual warning, hoist drum rotation indicator and Rated Capacity Indicator. Accessories include fire extinguisher; light package including headlights, tail lights, brake lights, directional signals, four-way hazard flashers, and back-up lights with audio pulsating back-up alarm; windshield and skylight washers/wipers; R.H. and L.H. rear view mirrors; dome light; dash lights; and seat belt.

HYDRAULIC CONTROL VALVES

Valves are mounted on the upperstructure and are easily accessible. Valves include one four-spool main valve for boom hoist, telescope and main winch, one single-spool valve for swing. High pressure regeneration feature provides 2-speed boom extension. Quick disconnects are provided for quick attachment of pressure check gauges.

OPTIONAL EQUIPMENT

Auxiliary Winch • 360° House Lock • Heater/Defroster • Air Conditioner • Tachometer • Work Lights • Revolving Amber Light • Independent Rear Wheel Steering • Roof Mounted Spotlight

STEERING

Hydraulic four-wheel power steering for two-wheel, four-wheel, or crab steer is easily controlled by steering wheel.

Turning radius to center of outside tire.

	21.00 x 25	26.5 x 25
Two-wheel	38' 0.6" (11.6 m)	38' 4.2" (11.7 m)
Four-wheel	20' 10.4" (6.4 m)	21' 1.9" (6.5 m)

TRANSMISSION

Full power-shift transmission with integral torque converter has neutral safety system, 6 speeds forward, and 3 speeds reverse. Automatic pulsating backup alarm.

STANDARD CARRIER EQUIPMENT (continued)

MULTI-POSITION OUT & DOWN OUTRIGGERS

Fully independent hydraulic outriggers may be utilized fully extended to 22 ft. (6.71 m), in their 1/2 extended position, or fully retracted. Easily removable floats, each with an area of 254 in² (1639 cm²), stow on the carrier frame. Complete controls and sight leveling bubble are located in the operator's cab.

WHEELS & TIRES

Disc type wheels with full tapered bead seat rim. 150.50 in (3.82 m) wheelbase.

TIRES

26.50x25, 26 P.R. (standard)
21.00x25, 28 P.R. (optional)

HYDRAULIC SYSTEM

HYDRAULIC PUMPS

Three gear type pumps, one single and two in tandem, driven off the transmission. Combined system capability is 119 gpm (450 lpm). Includes pump disconnect.

Main and Auxiliary Winch Pump

59.5 gpm (225.2 lpm) @ 3,500 psi (246.1 kg/cm²)

Boom Hoist, Telescope Pump

38.5 gpm (145.7 lpm) @ 3,500 psi (246.1 kg/cm²)

Power Steering, Outrigger and Swing Pump

21 gpm (79.5 lpm) @ 2,500 psi (175 kg/cm²)

MAIN WINCH SPECIFICATIONS

Hydraulic winch with planetary reduction gearing provides 2-speed operation with equal speeds for power up and down. Winch is equipped with an integral automatic brake, tapered drum flanges, electronic drum rotation indicator, and drum roller.

PERFORMANCE

Max. line speed (no load)

First layer

177 fpm (54 m/min)

293 fpm (89 m/min)

Fifth layer

257 fpm (78 m/min)

425 fpm (130 m/min)

Max. line pull-first layer

15,000 lbs (6804 kg)

Permissible line pull

10,000 lbs (4536 kg)

DRUM DIMENSIONS

10.62 in (270 mm) drum diameter

20.9 in (531 mm) length

19.8 in (503 mm) flange dia.

Cable: 5/8 in. x 500 ft (15.9 mm x 152.4 m)

Cable type: 6 x 19 IWRC-XIPS regular lay preformed

DRUM CAPACITY

Max. Storage: 899 ft (274 m)

7th layer not a working layer

Max. Useable: 738 ft (225 m)*

* Based on min. flange height above top layer to comply with ANSI B30.5

OPTIONAL HOIST LINE

MAIN WINCH - 5/8" (14.29 mm) rotation resistant, compacted strand, 16 x 19 or 19 x 19. Minimum break strength 22.7 tons (20.4 mt).

ENGINE SPECIFICATIONS

Make and Model	Cummins 6BTA5.9	Caterpillar 3116 DITA
Type	6 cylinder	6 cylinder
Bore and Stroke	4.02 x 4.72 in (102x120 mm)	4.12 x 5.0 in (105x127 mm)
Displacement	359 cu in (5.9 l)	402 cu in (6.6 l)
Gross HP	174 hp (130 kw) @ 2500 rpm	175 hp (130 kw) @ 2400 rpm
Gross Torque	455 lb•ft (617 N•m) @ 1500 rpm	490 lb•ft (664 N•m) @ 1450 rpm
Aspiration	turbocharged & aftercooled	turbocharged & aftercooled
Air Filter	dry type	dry type
Electrical System	12 volt	12 volt
Alternator	102 amp	115 amp
Battery	(2) 12V-1600 CCA	(2) 12V-1600 CCA
Fuel Capacity	50 gal (189 l)	50 gal (189 l)

SERVICE BRAKES

Air brakes on all four wheels; 20 1/4" x 4" (51.43x1010 cm) drum brakes.

PARKING BRAKE

Front and rear axles equipped with spring-set, air-released emergency/parking chambers.

OPTIONAL EQUIPMENT

Cold Weather Starting Aid • Immersion Heater • Rear Axle Centering Light • Pintle Hook • Clearance Lights • 24" (0.61 m) Aluminum Outrigger Floats • 31.5" (0.80 m) Stroke Jack Cylinders • Front Mounted Winch-20,000 lbs (9072 kg)

FILTRATION

Full flow oil filtration system with bypass protection includes a removable 60 mesh (250 micron) suction screen-type filter and 5 micron replaceable return line filter.

HYDRAULIC RESERVOIR

All steel, welded construction with internal baffles and diffuser. Provides easy access to filters and is equipped with an external sight level gauge. The hydraulic tank is pressurized to aid in keeping out contaminants and in reducing potential pump cavitation. Capacity is 114 gal (432 liters). Swing-away hydraulic oil cooler is standard.

OPTIONAL AUX. WINCH

Hydraulic winch, power up and down, equal speed, planetary reduction with integral automatic brake, tapered drum flanges, electronic drum rotation indicator, and drum roller.

STANDARD: Performance

Max. line speed (no load)

Fifth layer

338 fpm (103 m/min)

Max. line pull

First layer 10,100 lbs (4582 kg)

Drum Dimensions

10.5 in (267 mm) drum diameter

16.1 in (408 mm) length

17.8 in (452 mm) flange diameter

Cable: 1/2 in x 500 ft (12.7 mm x 152.4 m)

Cable type: 6 x 19 IWRC-XIPS regular lay preformed.

Drum Capacity

Max. storage: 815 ft (248 m).

HI-TORQUE:

Same as low speed main winch.

OPTIONAL AUXILIARY WINCH - 9/16 in. (15.88 mm) rotation resistant compacted strand, 18 x 19 or 19 x 19. Minimum break strength 18.5 tons (16.6 mt).

PERFORMANCE (Cummins 6BTA5.9 Engine)

Transmission Gear	Forward Drive	Maximum Speed	Maximum Tractive Effort	Gradeability @ Stall
1	4-wheel	2.4 mph 3.9 km/h	60,538 lbs 27,460 kg	127.6%
2	4-wheel	4.2 mph 6.8 km/h	34,255 lbs 15,538 kg	48.5%
3	4-wheel	5.6 mph 9.0 km/h	26,061 lbs 11,821 kg	34.7%
4	2-wheel	9.8 mph 15.8 km/h	14,765 lbs 6697 kg	18.0%
5	2-wheel	13.9 mph 22.4 km/h	10,410 lbs 4722 kg	12.0%
6	2-wheel	24.1 mph 38.8 km/h	5,960 lbs 2703 kg	5.9%

All performance data is based on a gross vehicle weight of 75,000 lbs (34,014 kg), 26.5x25 tires, 4x4 drive. Performance may vary due to engine performance. Gradeability data is theoretical and is limited by tire slip, stability, or engine oil pan design.

GENERAL DIMENSIONS

NOTES:

- Dimensions given assume the boom is fully retracted in travel position and 26.50x25 tires.
- Minimum ground clearance under:
 - transmission - 25.25" (0.64m)
 - axle bowls - 22.25" (0.57m)
 - tie rods - 25.5" (0.65m)

** The winch cable roller and drum rotation indicator increase the overall height by 4.50"

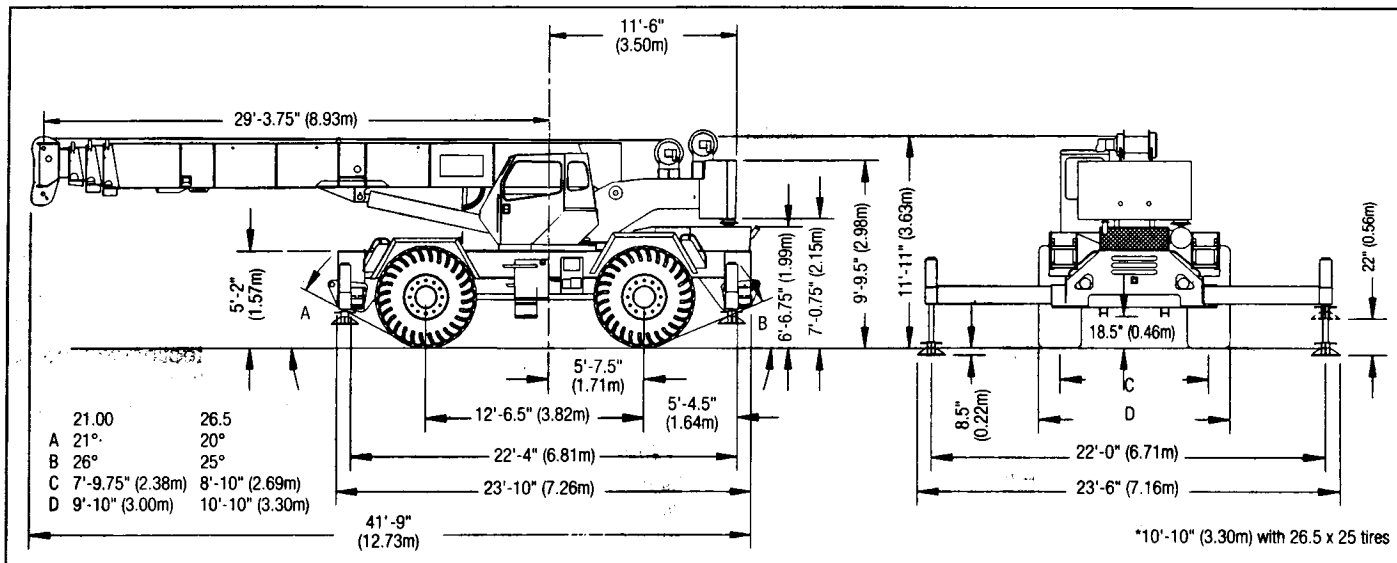

WEIGHTS & AXLE LOADS	GROSS WEIGHT LBS.	UPPER FACING FRONT		GROSS WEIGHT KG.	UPPER FACING FRONT	
		FRONT	REAR		FRONT	REAR
Basic Crane with 14,000 lb. (6349 kg) Counterweight and 26.5 x 25 26 PR Tires	76,095	37,192	38,903	34 516	16 870	17 646
Add Options:						
33' (10.06 m) Swing-on jib (Stowed)	+ 1,705	+2,850	-1,145	+ 773	+ 1293	- 520
33'-58' (10.06-17.68 m) Swing-On Jib (Stowed)	+ 2,545	+4,000	-1,455	+ 1154	+ 1814	- 660
Auxiliary Boom Head	+ 100	+ 285	- 185	+ 45	+ 129	- 84
Caterpillar 3116 DITA Engine	+ 180	- 15	+ 195	+ 82	- 7	+ 195
Aux. Winch, 1/2"x450' Wire Rope, Drum Roller	- 65	+ 15	- 80	- 29	+ 7	- 22
Hi-Torq Aux Winch 5/8"x500' Rope, Drum Roller	+ 298	- 45	+ 343	+ 135	- 20	+ 155
50T (45.3 mt) 6-Sheave Hook Block	+ 913	+1,367	- 454	+ 414	+ 620	- 206
50T (45.3 mt) 5-Sheave Hook Block	+ 888	+1,329	- 441	+ 403	+ 603	- 200
7.0T (6.3 mt) Hook and Ball (In tool box)	+ 240	+ 290	- 50	+ 109	+ 130	- 21
Pintle Hook:						
Front	+ 45	+ 60	- 15	+ 20	+ 27	- 7
Rear	+ 45	- 25	+ 70	+ 20	- 11	+ 31
Substitute:						
360° Mechanical House Lock	+ 85	- 38	+ 47	+ 39	- 17	+ 22
21.00 x 25 28 PR Tires	- 460	- 230	- 230	- 208	- 104	- 104
5/8" x 500' of 18x19 class spin resistant wire rope	+ 35	- 5	+ 40	+ 16	- 2	+ 18

NOTE: Weights are for factory supplied equipment and are subject to 2% variation due to manufacturing tolerances.

WE RESERVE THE RIGHT TO AMEND THESE SPECIFICATIONS AT ANY TIME WITHOUT NOTICE. THE ONLY WARRANTY APPLICABLE IS OUR STANDARD WRITTEN WARRANTY APPLICABLE TO THE PARTICULAR PRODUCT AND SALE. WE MAKE NO OTHER WARRANTY, EXPRESSED OR IMPLIED.

<http://www.terexlift.com>

TEREX CRANES

Waverly, Iowa

106 12th Street S.E. • Waverly, IA 50677-9466 USA
(319) 352-3920 • FAX: (319) 352-5727

TEREX RT 450

rough terrain crane
50 ton capacity

range diagram & lifting capacities

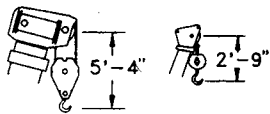

DIMENSIONS ARE FOR LARGEST FACTORY FURNISHED HOOK BLOCK AND HOOK & BALL, WITH ANTI-TWO BLOCK ACTIVATED

Range Diagram
(33' - 105' boom)

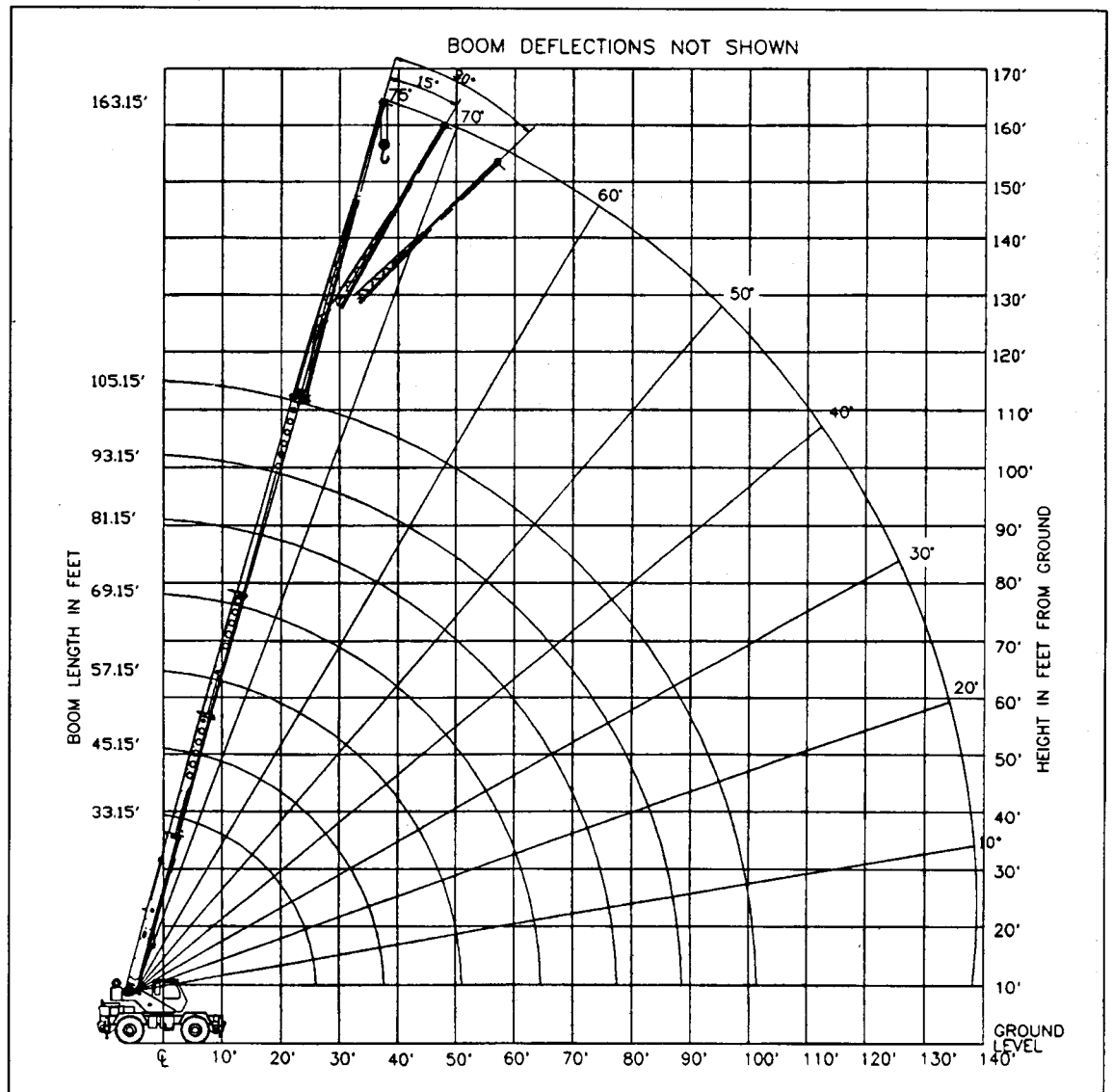

CRANE WORKING CONDITIONS

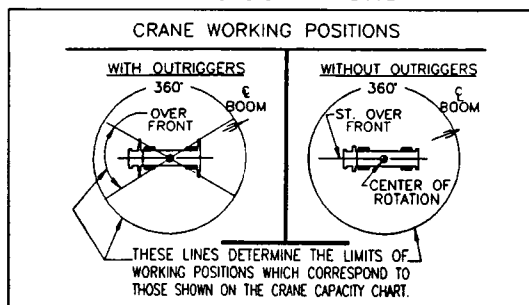

REDUCTION IN MAIN BOOM CAPACITY

All Jibs in Stowed Position	0 Lbs.
Aux. Boom in Head Sheave	100 Lbs.

HOOK BLOCK WEIGHTS

Hook & Ball	239 Lbs.
Hook Block (4 Sheave)	690 Lbs.
Hook Block (5 Sheave)	888 Lbs.
Hook Block (6 Sheave)	913 Lbs.

Lifting Capacities – Pounds (33' – 105' boom)

MODEL RT 450

COUNTERWEIGHT:
W/AUX. WINCH 13,100 LBS.
W/O AUX. WINCH 14,200 LBS.
BOOM LENGTH 33-105 FT.
OUTRIGGER SPREAD 22 FT.

STABILITY PCT.
ON OUTRIGGERS 85%
ON TIRES 75%
PCSA CLASS 10-176

CAUTION: Do not use this specification sheet as a load rating chart. The format of data is not consistent with the machine chart and may be subject to change.

ON OUTRIGGERS - FULLY EXTENDED

LOAD RADIUS (FT)	BOOM LENGTH 33.15 FT			BOOM LENGTH 45.15 FT			BOOM LENGTH 57.15 FT			LOAD RADIUS (FT)
	BOOM ANGLE (DEG)	LOADED OVER FRONT (LB)	360° (LB)	BOOM ANGLE (DEG)	LOADED OVER FRONT (LB)	360° (LB)	BOOM ANGLE (DEG)	LOADED OVER FRONT (LB)	360° (LB)	
10	65.3	100,000*	100,000*	72.2	75,100*	75,100*				10
12	61.5	76,200*	76,200*	69.5	73,100*	73,100*	73.9	59,700*	59,700*	12
15	55.4	64,300*	62,500*	65.4	61,800*	61,800*	70.8	55,100*	55,100*	15
20	44.0	46,300*	44,300*	58.1	47,200*	45,200*	65.4	47,700*	45,700*	20
25	29.6	34,800*	33,300*	50.3	35,800*	34,300*	59.7	36,300*	34,800*	25
30	**			41.5	28,100*	27,000*	53.7	28,700*	27,500*	30
35				30.7	22,700*	21,700*	47.2	23,200*	22,300*	35
40				13.9	18,500*	17,700*	39.9	19,100*	18,300*	40
45				**			31.3	15,900*	15,200*	45
50							19.6	13,300*	12,700*	50
55							**			55
60										60
65										65
70										70
75										75
80										80
85										85
90										90
95										95
100										100

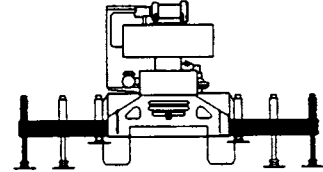

**USE THESE CHARTS ONLY
WHEN ALL OUTRIGGERS
ARE FULLY EXTENDED**

ON OUTRIGGERS - FULLY EXTENDED

LOAD RADIUS (FT)	BOOM LENGTH 69.15 FT			BOOM LENGTH 81.15 FT			BOOM LENGTH 93.15 FT			BOOM LENGTH 105.15 FT			LOAD RADIUS (FT)
	LOADED BOOM ANGLE (DEG)	OVER REAR (LB)	360° (LB)	LOADED BOOM ANGLE (DEG)	OVER REAR (LB)	360° (LB)	LOADED BOOM ANGLE (DEG)	OVER REAR (LB)	360° (LB)	LOADED BOOM ANGLE (DEG)	OVER REAR (LB)	360° (LB)	
10													10
12													12
15	74.2	44,000*	44,000*										15
20	69.8	36,200*	36,200*	72.9	33,500*	33,500*							20
25	65.4	30,400*	30,400*	69.2	28,400*	28,400*	72.0	22,200*	22,200*				25
30	60.7	26,100*	26,100*	65.4	24,300*	24,300*	68.7	19,000*	19,000*	71.2	15,100*	15,100*	30
35	55.8	22,800*	22,600*	61.4	21,100*	21,100*	65.4	16,300*	16,300*	68.3	13,400*	13,400*	35
40	50.7	19,500*	18,700*	57.3	18,700*	18,700*	61.9	14,300*	14,300*	65.4	12,000*	12,000*	40
45	45.1	16,300*	15,600*	53.0	16,500*	15,800*	58.4	12,400*	12,400*	62.3	10,800*	10,800*	45
50	38.9	13,800*	13,100*	48.4	14,000*	13,400*	54.7	10,900*	10,900*	59.2	9,600*	9,600*	50
55	31.7	11,500	10,900	43.5	11,700	11,000	50.8	9,700*	9,700*	56.0	8,600*	8,600*	55
60	22.6	9,500	8,900	38.1	9,700	9,100	46.7	8,700*	8,700*	52.6	7,600*	7,600*	60
65				32.0	8,100	7,600	42.4	7,800*	7,700	49.1	6,700*	6,700*	65
70				24.5	6,700	6,200	37.6	6,900	6,400	45.4	6,000*	6,000*	70
75				13.7	5,500	5,100	32.2	5,700	5,300	41.4	5,300*	5,300*	75
80				**			25.8	4,800	4,400	37.1	4,700*	4,500	80
85							17.5	3,900	3,500	32.3	4,000	3,700	85
90							**			26.8	3,300	2,900	90
95										20.0	2,600	2,300	95
100										9.1	2,000	1,700	100

** MAXIMUM CAPACITY AT 0 DEGREE BOOM ANGLE

BOOM LENGTH 33.15 FT			BOOM LENGTH 45.15 FT			BOOM LENGTH 57.15 FT			BOOM LENGTH 69.15 FT			BOOM LENGTH 81.15 FT			BOOM LENGTH 93.15 FT			BOOM LENGTH 105.15 FT		
LOAD RADIUS (FT)	OVER FRONT (LB)	360° (LB)	LOAD RADIUS (FT)	OVER FRONT (LB)	360° (LB)	LOAD RADIUS (FT)	OVER FRONT (LB)	360° (LB)	LOAD RADIUS (FT)	OVER FRONT (LB)	360° (LB)	LOAD RADIUS (FT)	OVER FRONT (LB)	360° (LB)	LOAD RADIUS (FT)	OVER FRONT (LB)	360° (LB)	LOAD RADIUS (FT)	OVER FRONT (LB)	360° (LB)
29.3	17,100*	17,100*	41.3	10,700*	10,700*	53.3	6,900*	6,900*	65.3	4,500*	4,500*	77.3	2,700*	2,700*	89.3	1,500*	1,500*	101.3	500*	500*

Lifting Capacities – Pounds (33’ – 105’ boom)

MODEL RT 450

COUNTERWEIGHT:
W/AUX. WINCH 13,100 LBS.
W/O AUX. WINCH 14,200 LBS.
BOOM LENGTH 33-105 FT.
OUTRIGGER SPREAD 22 FT.

STABILITY PCT.
ON OUTRIGGERS 85%
ON TIRES 75%
PCSA CLASS 10-176

CAUTION: Do not use this specification sheet as a load rating chart. The format of data is not consistent with the machine chart and may be subject to change.

ON OUTRIGGERS - MID POSITION

LOAD RADIUS (FT)	BOOM LENGTH 33.15 FT		BOOM LENGTH 45.15 FT		BOOM LENGTH 57.15 FT		BOOM LENGTH 69.15 FT		BOOM LENGTH 81.15 FT		BOOM LENGTH 93.15 FT		BOOM LENGTH 105.15 FT		LOAD RADIUS (FT)
	LOADED BOOM ANGLE (DEG)	360° (LB)	LOADED BOOM ANGLE (DEG)	360° (LB)	LOADED BOOM ANGLE (DEG)	360° (LB)	LOADED BOOM ANGLE (DEG)	360° (LB)	LOADED BOOM ANGLE (DEG)	360° (LB)	LOADED BOOM ANGLE (DEG)	360° (LB)	LOADED BOOM ANGLE (DEG)	360° (LB)	
10	65.3	87,000*	72.2	75,100*											10
12	61.5	70,900*	69.5	71,800*	73.9	59,700*									12
15	55.4	54,800*	65.4	55,700*	70.8	55,100*	74.2	44,000*							15
20	44.0	38,600*	58.1	39,500*	65.4	39,900*	69.8	36,200*	72.9	33,500*					20
25	29.6	25,300	50.3	26,400	59.7	26,700	65.4	26,900	69.2	27,000	72.0	22,200*			25
30	**		41.5	18,600	53.7	19,000	60.7	19,200	65.4	19,300	68.7	19,000*	71.2	15,100*	30
35			30.7	13,500	47.2	14,000	55.8	14,200	61.4	14,400	65.4	14,400	68.3	13,400*	35
40			13.9	9,800	39.9	10,600	50.7	10,800	57.3	10,900	61.9	11,000	65.4	11,100	40
45			**		31.3	8,000	45.1	8,300	53.0	8,500	58.4	8,500	62.3	8,600	45
50					19.6	5,900	38.9	6,300	48.4	6,600	54.7	6,600	59.2	6,700	50
55					**		31.7	4,800	43.5	5,000	50.8	5,100	56.0	5,200	55
60							22.6	3,500	38.1	3,800	46.7	3,900	52.6	4,000	60
65							**		32.0	2,700	42.4	2,900	49.1	3,000	65
70									24.5	1,800	37.6	2,000	45.4	2,100	70
75											32.2	1,300	41.4	1,400	75

** MAXIMUM CAPACITY AT 0 DEGREE BOOM ANGLE

BOOM LENGTH 33.15 FT		BOOM LENGTH 45.15 FT		BOOM LENGTH 57.15 FT		BOOM LENGTH 69.15 FT		BOOM LENGTH 81.15 FT		BOOM LENGTH 93.15 FT		BOOM LENGTH 105.15 FT	
LOAD RADIUS (FT)	360° (LB)	LOAD RADIUS (FT)	360° (LB)	LOAD RADIUS (FT)	360° (LB)	LOAD RADIUS (FT)	360° (LB)	LOAD RADIUS (FT)	360° (LB)	LOAD RADIUS (FT)	360° (LB)	LOAD RADIUS (FT)	360° (LB)
29.3	17,100*	41.3	8,900	53.3	4,700	65.3	2,300						

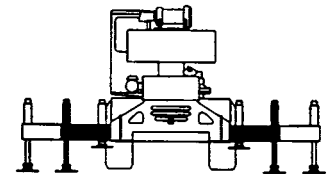

**USE THESE CHARTS ONLY
WHEN ALL OUTRIGGERS ARE
PINNED IN MID POSITION**

Lifting Capacities – Pounds (33’ – 105’ boom)

MODEL RT 450

COUNTERWEIGHT:
W/AUX. WINCH 13,100 LBS.
W/O AUX. WINCH 14,200 LBS.
BOOM LENGTH 33-105 FT.
OUTRIGGER SPREAD 22 FT.

STABILITY PCT.
ON OUTRIGGERS 85%
ON TIRES 75%
PCSA CLASS 10-176

CAUTION: Do not use this specification sheet as a load rating chart. The format of data is not consistent with the machine chart and may be subject to change.

ON OUTRIGGERS - RETRACTED

LOAD RADIUS (FT)	BOOM LENGTH 33.15 FT		BOOM LENGTH 45.15 FT		BOOM LENGTH 57.15 FT		BOOM LENGTH 69.15 FT		BOOM LENGTH 81.15 FT		BOOM LENGTH 93.15 FT		BOOM LENGTH 105.15 FT		LOAD RADIUS (FT)
	LOADED BOOM ANGLE (DEG)	360° (LB)	LOADED BOOM ANGLE (DEG)	360° (LB)	LOADED BOOM ANGLE (DEG)	360° (LB)	LOADED BOOM ANGLE (DEG)	360° (LB)	LOADED BOOM ANGLE (DEG)	360° (LB)	LOADED BOOM ANGLE (DEG)	360° (LB)	LOADED BOOM ANGLE (DEG)	360° (LB)	
10	65.3	70,000	72.2	70,700											10
12	61.5	48,900	69.5	49,500	73.9	49,800									12
15	55.4	32,300	65.4	33,000	70.8	33,300	74.2	33,400							15
20	44.0	18,700	58.1	19,700	65.4	20,000	69.8	20,100	72.9	20,200					20
25	29.6	11,700	50.3	12,700	59.7	13,100	65.4	13,300	69.2	13,400	72.0	13,500			25
30	**		41.5	8,400	53.7	8,900	60.7	9,200	65.4	9,300	68.7	9,300	71.2	9,400	30
35			30.7	5,500	47.2	6,000	55.8	6,300	61.4	6,500	65.4	6,600	68.3	6,600	35
40			13.9	3,300	39.9	3,900	50.7	4,300	57.3	4,500	61.9	4,600	65.4	4,600	40
45			**		7.9	2,300	45.1	2,700	53.0	2,900	58.4	3,000	62.3	3,100	45
50					19.6	1,100	38.9	1,500	48.4	1,700	54.7	1,800	59.2	1,900	50

** MAXIMUM CAPACITY AT 0 DEGREE BOOM ANGLE

BOOM LENGTH 33.15 FT		BOOM LENGTH 45.15 FT		BOOM LENGTH 57.15 FT		BOOM LENGTH 69.15 FT		BOOM LENGTH 81.15 FT		BOOM LENGTH 93.15 FT		BOOM LENGTH 105.15 FT	
LOAD RADIUS (FT)	360° (LB)	LOAD RADIUS (FT)	360° (LB)	LOAD RADIUS (FT)	360° (LB)	LOAD RADIUS (FT)	360° (LB)	LOAD RADIUS (FT)	360° (LB)	LOAD RADIUS (FT)	360° (LB)	LOAD RADIUS (FT)	360° (LB)
29.3	7,500	41.3	2,700										

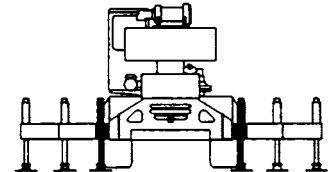

USE THESE CHARTS WHEN ALL OUTRIGGER BEAMS ARE NOT IN EITHER THE MID OR FULLY EXTENDED POSITION

Lifting Capacities – Pounds (33' – 105' boom)

MODEL RT 450

COUNTERWEIGHT:

W/AUX. WINCH 13,100 LBS.

W/O AUX. WINCH 14,200 LBS.

BOOM LENGTH 33-105 FT.

OUTRIGGER SPREAD 22 FT.

STABILITY PCT.

ON OUTRIGGERS 85%

ON TIRES 75%

PCSA CLASS 10-176



CAUTION: Do not use this specification sheet as a load rating chart. The format of data is not consistent with the machine chart and may be subject to change.

SIDE STOW JIB ON FULLY EXTENDED OUTRIGGERS

LOADED BOOM ANGLE (DEG)	33 FT OFFSETABLE JIB/NO PULL OUT INSTALLED						33 FT OFFSETABLE JIB/PULL OUT RETRACTED						58 FT OFFSETABLE JIB						LOADED BOOM ANGLE (DEG)
	0° OFFSET		15° OFFSET		30° OFFSET		0° OFFSET		15° OFFSET		30° OFFSET		0° OFFSET		15° OFFSET		30° OFFSET		
	LOAD RADIUS (REF) (FT)	360° (LB)	LOAD RADIUS (REF) (FT)	360° (LB)	LOAD RADIUS (REF) (FT)	360° (LB)	LOAD RADIUS (REF) (FT)	360° (LB)	LOAD RADIUS (REF) (FT)	360° (LB)	LOAD RADIUS (REF) (FT)	360° (LB)	LOAD RADIUS (REF) (FT)	360° (LB)	LOAD RADIUS (REF) (FT)	360° (LB)	LOAD RADIUS (REF) (FT)	360° (LB)	
75	38	9,100*	46	7,300*	52	6,100*	38	9,100*	46	7,300*	52	6,100*	50	5,100*	64	4,100*	75	3,400*	75
73	43	7,800*	50	6,700*	57	5,600*	43	7,800*	50	6,700*	57	5,600*	55	4,800*	69	3,900*	79	3,300*	73
70	50	7,600*	56	6,400*	63	5,500*	50	7,400*	56	6,000*	63	5,100*	63	4,600*	76	3,600*	86	3,000*	70
67	57	7,400*	63	6,000*	69	5,200*	57	6,800*	63	5,500*	69	4,700*	71	4,500*	83	3,300*	92	2,800*	67
64	63	6,400*	69	5,300*	75	4,700*	63	5,800*	69	4,800*	75	4,100*	78	4,400*	90	3,000*	98	2,600*	64
61	70	5,600*	76	4,800*	81	4,200*	70	5,000*	76	4,200*	81	3,700*	86	4,000*	97	2,900*	104	2,300*	61
58	76	5,000*	81	4,300*	86	3,800*	76	4,300*	81	3,700*	86	3,300*	93	3,600*	103	2,700*	110	2,300*	58
54	83	4,300*	88	3,800*	93	3,400*	83	3,600*	88	3,100*	93	2,800*	102	3,100*	111	2,600*	117	2,200*	54
50	90	3,800*	95	3,300*	99	3,100*	90	3,100*	95	2,700*	99	2,500*	110	2,700*	118	2,300*	123	2,000*	50
46	97	3,300*	101	2,900*	105	2,700*	97	2,600*	101	2,300*	105	2,100*	117	2,000	124	1,900	128	1,800*	46
42	103	2,900*	107	2,700*	110	2,500*	103	2,200*	107	2,000*	110	1,900*	123	1,400	130	1,300	133	1,300	42
38	109	2,200	112	2,000	115	1,800	109	1,500	112	1,400	115	1,300	129	1,100					38
32	117	1,500	116	1,400	121	1,400													32

NOTES FOR JIB CAPACITIES

- A. For all boom lengths less than the maximum with a jib erected, the rated loads are determined by boom angle only in the appropriate column.
 B. For boom angle not shown, use the capacity of the next lower boom angle.
 C. Listed radii are for extended main boom only.

ON TIRES

RADIUS (FT)	MAX BOOM LENGTH (FT)	21:00 X 25-28PR				26.5 x 25-26PR				RADIUS (FT)
		STATIONARY		PICK & CARRY		STATIONARY		PICK & CARRY		
		360°	STRAIGHT OVER FRONT	2.5 MPH	CREEP	360°	STRAIGHT OVER FRONT	2.5 MPH	CREEP	
10	33	36,000	70,000*	53,100*	47,200*	39,500*	61,800*	47,200*	39,800*	10
12	33	30,600	64,900*	49,400*	43,700*	32,100*	57,000*	43,300*	36,300*	12
15	33	22,900	53,500	41,800*	35,900*	23,000	48,800*	36,600*	30,200*	15
20	45	14,000	31,800	31,800	27,000*	14,700	33,200	27,500*	22,500*	20
25	45	9,300	21,700	22,000	21,000	10,500	21,500	21,200	17,100*	25
30	45	6,100	15,300	15,300	15,300	7,500	15,400	15,400	13,000*	30
35	45	4,000	12,000	12,000	12,000	5,200	11,900	11,900	10,300*	35
40	57	2,400	9,400	9,400	9,400	3,500	9,500	9,500	8,200*	40
45	57		7,400	7,400	7,400	2,000	7,600	7,600	6,500*	45
50	57		6,000	6,000	6,000		6,000	6,000	5,100*	50
55	69		4,700	4,700	4,700		4,700	4,700	4,000*	55
60	69		3,600	3,600	3,600		3,600	3,600	3,000*	60

NOTES FOR ON TIRE CAPACITIES

- A. For Pick and Carry operations, boom must be centered over the front of the crane with swing brake and lock engaged. Use minimum boom point height and keep load close to ground surface.
 B. The load should be restrained from swinging. NO ON TIRE OPERATION WITH JIB ERECTED.
 C. Without outriggers, never maneuver the boom beyond listed load radii for applicable tires to ensure stability.
 D. Creep speed is crane movement of less than 200 Ft. (61m) in a 30 minute period and not exceeding 1.0 mph (1.6 km/h).
 E. Refer to General Notes for additional information.

MAXIMUM PERMISSIBLE HOIST LINE LOAD

LINE PARTS	1	2	3	4	5	6	7	8	9	10
STD. HOIST	10,000	20,000	30,000	40,000	50,000	60,000	70,000	80,000	90,000	100,000
AUX HOIST	9,080	18,160	27,240	36,320	45,400	54,480	65,560	70,000	81,270	90,000
HOOK BLOCK	7,400	14,800	22,200	29,600	37,000	44,400	51,800	59,200	66,600	74,000
WIRE ROPE: 5/8" ROTATION RESISTANT COMPACTED STRAND, 18X19 OR 19X19 MINIMUM BREAKING STRENGTH - 22.7 TONS 5/8" 6X19 OR 6X37 IWRC IPS PREFORMED RIGHT REGULAR LAY MINIMUM BREAKING STRENGTH - 17.9 TONS										

RECOMMENDED TIRE PRESSURE

TIRE SIZE	STATIONARY	CREEP	2 1/2 MPH	TRAVEL
21:00 X 25-28 PR	85 PSI	85 PSI	85 PSI	65 PSI
26:50 X 25-26 PR	65 PSI	65 PSI	65 PSI	50 PSI

GENERAL NOTES

GENERAL

1. Rated loads as shown on Lift Charts pertain to this machine as originally manufactured and equipped. Modifications to the machine or use of optional equipment other than that specified can result in a reduction of capacity.
2. Construction equipment can be hazardous if improperly operated or maintained. Operation and maintenance of this machine shall be in compliance with the information in the Operator's, Parts and Safety Manuals supplied with this machine. If these manuals are missing, order replacements from the manufacturer through your distributor.
3. These warnings do not constitute all of the operating conditions for the crane. The operator and job site supervision must read the OPERATORS MANUAL, CIMA SAFETY MANUAL, APPLICABLE OSHA REGULATIONS, AND SOCIETY OF MECHANICAL ENGINEERS (ASME) SAFETY STANDARDS FOR CRANES.
4. This crane and its load ratings are in accordance with POWER CRANE & SHOVEL ASSOCIATION, STANDARD NO. 4, SAE CRANE LOAD STABILITY TEST CODE J765A, SAE METHOD OF TEST FOR CRANE STRUCTURE J1063 AND APPLICABLE SAFETY CODE FOR CRANES, DERRICKS AND HOISTS, ASME/ANSI B30.5.

DEFINITIONS

1. **LOAD RADIUS** – The horizontal distance from the axis of rotation before loading to the center of the vertical hoist line or tackle with a load applied.
2. **LOADED BOOM ANGLE** – It is the angle between the boom base section and the horizontal, after lifting the rated load at the rated radius. The boom angle before loading should be greater to account for deflections. The loaded boom angle combined with boom length give only an approximation of the operating radius.
3. **WORKING AREA** – Areas measured in a circular arc about the centerline of rotation as shown in the diagram.
4. **FREELY SUSPENDED LOAD** – Load hanging free with no direct external force applied except by the hoist rope.
5. **SIDE LOAD** – Horizontal force applied to the lifted load either on the ground or in the air.
6. **NO LOAD STABILITY LIMIT** – The stability limit radius shown on the range diagrams is the radius beyond which it is not permitted to position the boom, when the boom angle is less than the minimum shown on the applicable load chart, because the machine can overturn without any load.

SET-UP

1. Crane load ratings are based on the crane being leveled and standing on a firm, uniform supporting surface.
2. Crane load ratings on outriggers are based on all outrigger beams being fully extended or in the case of partial extension ratings mechanically pinned in the appropriate position, and the tires free of the supporting surface.
3. Crane load ratings on tires depend on appropriate inflation pressure and the tire conditions. Caution must be exercised when increasing air pressures in tires. Consult Operator's Manual for precautions.
4. Use of jibs, lattice-type boom extensions, or fourth section pullouts extended is not permitted for pick and carry operations.
5. Consult appropriate section of the Operator's and Service Manual for more exact description of hoist line reeving.
6. The use of more parts of line than required by the load may result in having insufficient rope to allow the hook block to reach the ground.
7. Properly maintained wire rope is essential for safe crane operation. Consult Operator's Manual for proper maintenance and inspection requirements.

8. When spin-resistant wire rope is used, the allowable rope loading shall be the breaking strength divided by five (5), unless otherwise specified by the wire rope manufacturer.

OPERATION

1. **CRANE LOAD RATINGS MUST NOT BE EXCEEDED. DO NOT ATTEMPT TO TIP THE CRANE TO DETERMINE ALLOWABLE LOADS.**
2. When either radius or boom length, or both, are between listed values, the smaller of the two listed load ratings shall be used.
3. Do not operate at longer radii than those listed on the applicable load rating chart (cross hatched areas shown on range diagrams).
4. The boom angles shown on the Capacity Chart give an approximation of the operating radius for a specified boom length. The boom angle, before loading, should be greater to account for boom deflection. It may be necessary to retract the boom if maximum boom angle is insufficient to maintain rated radius.
5. Power telescoping boom sections must be extended equally.
6. Rated loads include the weight of hook block, slings, and auxiliary lifting devices. Their weights shall be subtracted from the listed rated load to obtain the net load that can be lifted.
When lifting over the jib the weight of any hook block, slings, and auxiliary lifting devices at the boom head must be added to the load.
When jibs are erected but unused add two (2) times the weight of any hook block, slings, and auxiliary lifting devices at the jib head to the load.
7. Rated loads do not exceed 85% on outriggers or 75% on tires, of the tipping load as determined by SAE Crane Stability Test Code J765a. Rated loads for partially extended outriggers are determined from the formula, Rated Load = (Tipping Load – 0.1 X Tip Reaction) / 1.25. Structural strength ratings in chart are indicated with an asterisk (*).
8. Rated loads are based on freely suspended loads. No attempt shall be made to drag a load horizontally on the ground in any direction.
9. The user shall operate at reduced ratings to allow for adverse job conditions, such as: Soft or uneven ground, out of level conditions, high winds, side loads, pendulum action, jerking or sudden stopping of loads, hazardous conditions, experience of personnel, two machine lifts, traveling with loads, electric wires, etc., (side pull on boom or jib is hazardous). Derating of the cranes lifting capacity is required when wind speed exceeds 20 MPH. The center of the lifted load must never be allowed to move more than 3" feet off the center line of the base boom section due to the effects of wind, inertia, or any combination of the two.
**"Use 2 feet off the center line of the base boom for a two section boom, 3 feet for a three section boom, or 4 feet for a four section boom."
10. The maximum load which can be telescoped is not definable, because of variations in loadings and crane maintenance, but it is permissible to attempt retraction and extension if load ratings are not exceeded.
11. Load ratings are dependent upon the crane being maintained according to manufacturer's specifications.
12. It is recommended that load handling devices, including hooks, and hook blocks, be kept away from boom head at all times.
13. **FOR TRUCK ONLY:** 360° capacities apply only to machines equipped with a front outrigger jack and all five (5) outrigger jacks properly set. If the front (5th) outrigger jack is not properly set, the work area is restricted to the over side and over rear areas as shown on the Crane Working Positions diagram. Use the 360° load ratings in the overside work areas.

WE RESERVE THE RIGHT TO AMEND THESE SPECIFICATIONS AT ANY TIME WITHOUT NOTICE. THE ONLY WARRANTY APPLICABLE IS OUR STANDARD WRITTEN WARRANTY APPLICABLE TO THE PARTICULAR PRODUCT AND SALE. WE MAKE NO OTHER WARRANTY, EXPRESSED OR IMPLIED.

<http://www.terexlift.com>

 **TEREX CRANES**

Waverly, Iowa

TEREX CRANES, INC.
106 12th Street S.E. • Waverly, IA 50677-9466 USA
(319) 352-3920 • FAX: (319) 352-5727

Lifting Capacities – Pounds (33' – 105' boom)

MODEL RT 450

COUNTERWEIGHT:
W/AUX. WINCH 13,100 LBS.
W/O AUX. WINCH 14,200 LBS.
BOOM LENGTH 33-105 FT.
OUTRIGGER SPREAD 22 FT.

STABILITY PCT.
ON OUTRIGGERS 85%
ON TIRES 75%
PCSA CLASS 10-176

CAUTION: Do not use this specification sheet as a load rating chart. The format of data is not consistent with the machine chart and may be subject to change.

ON OUTRIGGERS - FULLY EXTENDED

LOAD RADIUS (FT)	BOOM LENGTH 33.15 FT			BOOM LENGTH 45.15 FT			BOOM LENGTH 57.15 FT			LOAD RADIUS (FT)
	BOOM ANGLE (DEG)	LOADED OVER FRONT (LB)	360° (LB)	BOOM ANGLE (DEG)	LOADED OVER FRONT (LB)	360° (LB)	BOOM ANGLE (DEG)	LOADED OVER FRONT (LB)	360° (LB)	
10	65.3	100,000*	100,000*	72.2	75,100*	75,100*				10
12	61.5	76,200*	76,200*	69.5	73,100*	73,100*	73.9	59,700*	59,700*	12
15	55.4	64,300*	62,500*	65.4	61,800*	61,800*	70.8	55,100*	55,100*	15
20	44.0	46,300*	44,300*	58.1	47,200*	45,200*	65.4	47,700*	45,700*	20
25	29.6	34,800*	33,300*	50.3	35,800*	34,300*	59.7	36,300*	34,800*	25
30	**			41.5	28,100*	27,000*	53.7	28,700*	27,500*	30
35				30.7	22,700*	21,700*	47.2	23,200*	22,300*	35
40				13.9	18,500*	17,700*	39.9	19,100*	18,300*	40
45				**			31.3	15,900*	15,200*	45
50							19.6	13,300*	12,700*	50
55							**			55
60										60
65										65
70										70
75										75
80										80
85										85
90										90
95										95
100										100

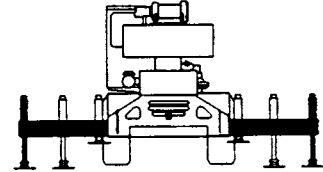

**USE THESE CHARTS ONLY
WHEN ALL OUTRIGGERS
ARE FULLY EXTENDED**

ON OUTRIGGERS - FULLY EXTENDED

LOAD RADIUS (FT)	BOOM LENGTH 69.15 FT			BOOM LENGTH 81.15 FT			BOOM LENGTH 93.15 FT			BOOM LENGTH 105.15 FT			LOAD RADIUS (FT)
	LOADED BOOM ANGLE (DEG)	OVER REAR (LB)	360° (LB)	LOADED BOOM ANGLE (DEG)	OVER REAR (LB)	360° (LB)	LOADED BOOM ANGLE (DEG)	OVER REAR (LB)	360° (LB)	LOADED BOOM ANGLE (DEG)	OVER REAR (LB)	360° (LB)	
10													10
12													12
15	74.2	44,000*	44,000*										15
20	69.8	36,200*	36,200*	72.9	33,500*	33,500*							20
25	65.4	30,400*	30,400*	69.2	28,400*	28,400*	72.0	22,200*	22,200*				25
30	60.7	26,100*	26,100*	65.4	24,300*	24,300*	68.7	19,000*	19,000*	71.2	15,100*	15,100*	30
35	55.8	22,800*	22,600*	61.4	21,100*	21,100*	65.4	16,300*	16,300*	68.3	13,400*	13,400*	35
40	50.7	19,500*	18,700*	57.3	18,700*	18,700*	61.9	14,300*	14,300*	65.4	12,000*	12,000*	40
45	45.1	16,300*	15,600*	53.0	16,500*	15,800*	58.4	12,400*	12,400*	62.3	10,800*	10,800*	45
50	38.9	13,800*	13,100*	48.4	14,000*	13,400*	54.7	10,900*	10,900*	59.2	9,600*	9,600*	50
55	31.7	11,500	10,900	43.5	11,700	11,000	50.8	9,700*	9,700*	56.0	8,600*	8,600*	55
60	22.6	9,500	8,900	38.1	9,700	9,100	46.7	8,700*	8,700*	52.6	7,600*	7,600*	60
65				32.0	8,100	7,600	42.4	7,800*	7,700	49.1	6,700*	6,700*	65
70				24.5	6,700	6,200	37.6	6,900	6,400	45.4	6,000*	6,000*	70
75				13.7	5,500	5,100	32.2	5,700	5,300	41.4	5,300*	5,300*	75
80				**			25.8	4,800	4,400	37.1	4,700*	4,500	80
85							17.5	3,900	3,500	32.3	4,000	3,700	85
90							**			26.8	3,300	2,900	90
95										20.0	2,600	2,300	95
100										9.1	2,000	1,700	100

** MAXIMUM CAPACITY AT 0 DEGREE BOOM ANGLE

BOOM LENGTH 33.15 FT			BOOM LENGTH 45.15 FT			BOOM LENGTH 57.15 FT			BOOM LENGTH 69.15 FT			BOOM LENGTH 81.15 FT			BOOM LENGTH 93.15 FT			BOOM LENGTH 105.15 FT		
LOAD RADIUS (FT)	OVER FRONT (LB)	360° (LB)	LOAD RADIUS (FT)	OVER FRONT (LB)	360° (LB)	LOAD RADIUS (FT)	OVER FRONT (LB)	360° (LB)	LOAD RADIUS (FT)	OVER FRONT (LB)	360° (LB)	LOAD RADIUS (FT)	OVER FRONT (LB)	360° (LB)	LOAD RADIUS (FT)	OVER FRONT (LB)	360° (LB)	LOAD RADIUS (FT)	OVER FRONT (LB)	360° (LB)
29.3	17,100*	17,100*	41.3	10,700*	10,700*	53.3	6,900*	6,900*	65.3	4,500*	4,500*	77.3	2,700*	2,700*	89.3	1,500*	1,500*	101.3	500*	500*

Lifting Capacities – Pounds (33’ – 105’ boom)

MODEL RT 450

COUNTERWEIGHT:
W/AUX. WINCH 13,100 LBS.
W/O AUX. WINCH 14,200 LBS.
BOOM LENGTH 33-105 FT.
OUTRIGGER SPREAD 22 FT.

STABILITY PCT.
ON OUTRIGGERS 85%
ON TIRES 75%
PCSA CLASS 10-176

CAUTION: Do not use this specification sheet as a load rating chart. The format of data is not consistent with the machine chart and may be subject to change.

ON OUTRIGGERS - MID POSITION

LOAD RADIUS (FT)	BOOM LENGTH 33.15 FT		BOOM LENGTH 45.15 FT		BOOM LENGTH 57.15 FT		BOOM LENGTH 69.15 FT		BOOM LENGTH 81.15 FT		BOOM LENGTH 93.15 FT		BOOM LENGTH 105.15 FT		LOAD RADIUS (FT)
	LOADED BOOM ANGLE (DEG)	360° (LB)	LOADED BOOM ANGLE (DEG)	360° (LB)	LOADED BOOM ANGLE (DEG)	360° (LB)	LOADED BOOM ANGLE (DEG)	360° (LB)	LOADED BOOM ANGLE (DEG)	360° (LB)	LOADED BOOM ANGLE (DEG)	360° (LB)	LOADED BOOM ANGLE (DEG)	360° (LB)	
10	65.3	87,000*	72.2	75,100*											10
12	61.5	70,900*	69.5	71,800*	73.9	59,700*									12
15	55.4	54,800*	65.4	55,700*	70.8	55,100*	74.2	44,000*							15
20	44.0	38,600*	58.1	39,500*	65.4	39,900*	69.8	36,200*	72.9	33,500*					20
25	29.6	25,300	50.3	26,400	59.7	26,700	65.4	26,900	69.2	27,000	72.0	22,200*			25
30	**		41.5	18,600	53.7	19,000	60.7	19,200	65.4	19,300	68.7	19,000*	71.2	15,100*	30
35			30.7	13,500	47.2	14,000	55.8	14,200	61.4	14,400	65.4	14,400	68.3	13,400*	35
40			13.9	9,800	39.9	10,600	50.7	10,800	57.3	10,900	61.9	11,000	65.4	11,100	40
45			**		31.3	8,000	45.1	8,300	53.0	8,500	58.4	8,500	62.3	8,600	45
50					19.6	5,900	38.9	6,300	48.4	6,600	54.7	6,600	59.2	6,700	50
55					**		31.7	4,800	43.5	5,000	50.8	5,100	56.0	5,200	55
60							22.6	3,500	38.1	3,800	46.7	3,900	52.6	4,000	60
65							**		32.0	2,700	42.4	2,900	49.1	3,000	65
70									24.5	1,800	37.6	2,000	45.4	2,100	70
75											32.2	1,300	41.4	1,400	75

** MAXIMUM CAPACITY AT 0 DEGREE BOOM ANGLE

BOOM LENGTH 33.15 FT		BOOM LENGTH 45.15 FT		BOOM LENGTH 57.15 FT		BOOM LENGTH 69.15 FT		BOOM LENGTH 81.15 FT		BOOM LENGTH 93.15 FT		BOOM LENGTH 105.15 FT	
LOAD RADIUS (FT)	360° (LB)	LOAD RADIUS (FT)	360° (LB)	LOAD RADIUS (FT)	360° (LB)	LOAD RADIUS (FT)	360° (LB)	LOAD RADIUS (FT)	360° (LB)	LOAD RADIUS (FT)	360° (LB)	LOAD RADIUS (FT)	360° (LB)
29.3	17,100*	41.3	8,900	53.3	4,700	65.3	2,300						

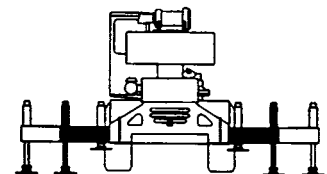

**USE THESE CHARTS ONLY
WHEN ALL OUTRIGGERS ARE
PINNED IN MID POSITION**

Lifting Capacities – Pounds (33' – 105' boom)

MODEL RT 450

COUNTERWEIGHT:
W/AUX. WINCH 13,100 LBS.
W/O AUX. WINCH 14,200 LBS.
BOOM LENGTH 33-105 FT.
OUTRIGGER SPREAD 22 FT.

STABILITY PCT.
ON OUTRIGGERS 85%
ON TIRES 75%
PCSA CLASS 10-176

CAUTION: Do not use this specification sheet as a load rating chart. The format of data is not consistent with the machine chart and may be subject to change.

ON OUTRIGGERS - RETRACTED

LOAD RADIUS (FT)	BOOM LENGTH 33.15 FT		BOOM LENGTH 45.15 FT		BOOM LENGTH 57.15 FT		BOOM LENGTH 69.15 FT		BOOM LENGTH 81.15 FT		BOOM LENGTH 93.15 FT		BOOM LENGTH 105.15 FT		LOAD RADIUS (FT)
	LOADED BOOM ANGLE (DEG)	360° (LB)	LOADED BOOM ANGLE (DEG)	360° (LB)	LOADED BOOM ANGLE (DEG)	360° (LB)	LOADED BOOM ANGLE (DEG)	360° (LB)	LOADED BOOM ANGLE (DEG)	360° (LB)	LOADED BOOM ANGLE (DEG)	360° (LB)	LOADED BOOM ANGLE (DEG)	360° (LB)	
10	65.3	70,000	72.2	70,700											10
12	61.5	48,900	69.5	49,500	73.9	49,800									12
15	55.4	32,300	65.4	33,000	70.8	33,300	74.2	33,400							15
20	44.0	18,700	58.1	19,700	65.4	20,000	69.8	20,100	72.9	20,200					20
25	29.6	11,700	50.3	12,700	59.7	13,100	65.4	13,300	69.2	13,400	72.0	13,500			25
30	**		41.5	8,400	53.7	8,900	60.7	9,200	65.4	9,300	68.7	9,300	71.2	9,400	30
35			30.7	5,500	47.2	6,000	55.8	6,300	61.4	6,500	65.4	6,600	68.3	6,600	35
40			13.9	3,300	39.9	3,900	50.7	4,300	57.3	4,500	61.9	4,600	65.4	4,600	40
45			**		7.9	2,300	45.1	2,700	53.0	2,900	58.4	3,000	62.3	3,100	45
50					19.6	1,100	38.9	1,500	48.4	1,700	54.7	1,800	59.2	1,900	50

** MAXIMUM CAPACITY AT 0 DEGREE BOOM ANGLE

BOOM LENGTH 33.15 FT		BOOM LENGTH 45.15 FT		BOOM LENGTH 57.15 FT		BOOM LENGTH 69.15 FT		BOOM LENGTH 81.15 FT		BOOM LENGTH 93.15 FT		BOOM LENGTH 105.15 FT	
LOAD RADIUS (FT)	360° (LB)	LOAD RADIUS (FT)	360° (LB)	LOAD RADIUS (FT)	360° (LB)	LOAD RADIUS (FT)	360° (LB)	LOAD RADIUS (FT)	360° (LB)	LOAD RADIUS (FT)	360° (LB)	LOAD RADIUS (FT)	360° (LB)
29.3	7,500	41.3	2,700										

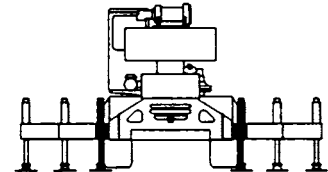

USE THESE CHARTS WHEN ALL OUTRIGGER BEAMS ARE NOT IN EITHER THE MID OR FULLY EXTENDED POSITION

Lifting Capacities – Pounds (33' – 105' boom)

MODEL RT 450

COUNTERWEIGHT: W/AUX. WINCH 13,100 LBS.
 W/O AUX. WINCH 14,200 LBS.
 BOOM LENGTH 33-105 FT.
 OUTRIGGER SPREAD 22 FT.

STABILITY PCT. ON OUTRIGGERS 85%
 ON TIRES 75%
 PCSA CLASS 10-176

CAUTION: Do not use this specification sheet as a load rating chart. The format of data is not consistent with the machine chart and may be subject to change.

SIDE STOW JIB ON FULLY EXTENDED OUTRIGGERS

LOADED BOOM ANGLE (DEG)	33 FT OFFSETABLE JIB/NO PULL OUT INSTALLED						33 FT OFFSETABLE JIB/PULL OUT RETRACTED						58 FT OFFSETABLE JIB						LOADED BOOM ANGLE (DEG)
	0° OFFSET		15° OFFSET		30° OFFSET		0° OFFSET		15° OFFSET		30° OFFSET		0° OFFSET		15° OFFSET		30° OFFSET		
	LOAD RADIUS (REF) (FT)	360° (LB)	LOAD RADIUS (REF) (FT)	360° (LB)	LOAD RADIUS (REF) (FT)	360° (LB)	LOAD RADIUS (REF) (FT)	360° (LB)	LOAD RADIUS (REF) (FT)	360° (LB)	LOAD RADIUS (REF) (FT)	360° (LB)	LOAD RADIUS (REF) (FT)	360° (LB)	LOAD RADIUS (REF) (FT)	360° (LB)	LOAD RADIUS (REF) (FT)	360° (LB)	
75	38	9,100*	46	7,300*	52	6,100*	38	9,100*	46	7,300*	52	6,100*	50	5,100*	64	4,100*	75	3,400*	75
73	43	7,800*	50	6,700*	57	5,600*	43	7,800*	50	6,700*	57	5,600*	55	4,800*	69	3,900*	79	3,300*	73
70	50	7,600*	56	6,400*	63	5,500*	50	7,400*	56	6,000*	63	5,100*	63	4,600*	76	3,600*	86	3,000*	70
67	57	7,400*	63	6,000*	69	5,200*	57	6,800*	63	5,500*	69	4,700*	71	4,500*	83	3,300*	92	2,800*	67
64	63	6,400*	69	5,300*	75	4,700*	63	5,800*	69	4,800*	75	4,100*	78	4,400*	90	3,000*	98	2,600*	64
61	70	5,600*	76	4,800*	81	4,200*	70	5,000*	76	4,200*	81	3,700*	86	4,000*	97	2,900*	104	2,300*	61
58	76	5,000*	81	4,300*	86	3,800*	76	4,300*	81	3,700*	86	3,300*	93	3,600*	103	2,700*	110	2,300*	58
54	83	4,300*	88	3,800*	93	3,400*	83	3,600*	88	3,100*	93	2,800*	102	3,100*	111	2,600*	117	2,200*	54
50	90	3,800*	95	3,300*	99	3,100*	90	3,100*	95	2,700*	99	2,500*	110	2,700*	118	2,300*	123	2,000*	50
46	97	3,300*	101	2,900*	105	2,700*	97	2,600*	101	2,300*	105	2,100*	117	2,000	124	1,900	128	1,800*	46
42	103	2,900*	107	2,700*	110	2,500*	103	2,200*	107	2,000*	110	1,900*	123	1,400	130	1,300	133	1,300	42
38	109	2,200	112	2,000	115	1,800	109	1,500	112	1,400	115	1,300	129	1,100					38
32	117	1,500	116	1,400	121	1,400													32

NOTES FOR JIB CAPACITIES

- A. For all boom lengths less than the maximum with a jib erected, the rated loads are determined by boom angle only in the appropriate column.
 B. For boom angle not shown, use the capacity of the next lower boom angle.
 C. Listed radii are for extended main boom only.

ON TIRES

RADIUS (FT)	MAX BOOM LENGTH (FT)	21:00 X 25-28PR				26.5 x 25-26PR				RADIUS (FT)
		STATIONARY		PICK & CARRY		STATIONARY		PICK & CARRY		
		360°	STRAIGHT OVER FRONT	2.5 MPH	CREEP	360°	STRAIGHT OVER FRONT	2.5 MPH	CREEP	
10	33	36,000	70,000*	53,100*	47,200*	39,500*	61,800*	47,200*	39,800*	10
12	33	30,600	64,900*	49,400*	43,700*	32,100*	57,000*	43,300*	36,300*	12
15	33	22,900	53,500	41,800*	35,900*	23,000	48,800*	36,600*	30,200*	15
20	45	14,000	31,800	31,800	27,000*	14,700	33,200	27,500*	22,500*	20
25	45	9,300	21,700	22,000	21,000	10,500	21,500	21,200	17,100*	25
30	45	6,100	15,300	15,300	15,300	7,500	15,400	15,400	13,000*	30
35	45	4,000	12,000	12,000	12,000	5,200	11,900	11,900	10,300*	35
40	57	2,400	9,400	9,400	9,400	3,500	9,500	9,500	8,200*	40
45	57		7,400	7,400	7,400	2,000	7,600	7,600	6,500*	45
50	57		6,000	6,000	6,000		6,000	6,000	5,100*	50
55	69		4,700	4,700	4,700		4,700	4,700	4,000*	55
60	69		3,600	3,600	3,600		3,600	3,600	3,000*	60

NOTES FOR ON TIRE CAPACITIES

- A. For Pick and Carry operations, boom must be centered over the front of the crane with swing brake and lock engaged. Use minimum boom point height and keep load close to ground surface.
 B. The load should be restrained from swinging. NO ON TIRE OPERATION WITH JIB ERECTED.
 C. Without outriggers, never maneuver the boom beyond listed load radii for applicable tires to ensure stability.
 D. Creep speed is crane movement of less than 200 Ft. (61m) in a 30 minute period and not exceeding 1.0 mph (1.6 km/h).
 E. Refer to General Notes for additional information.

MAXIMUM PERMISSIBLE HOIST LINE LOAD

LINE PARTS	1	2	3	4	5	6	7	8	9	10
STD. HOIST	10,000	20,000	30,000	40,000	50,000	60,000	70,000	80,000	90,000	100,000
AUX HOIST	9,080	18,160	27,240	36,320	45,400	54,480	65,560	70,000	81,270	90,000
HOOK BLOCK	7,400	14,800	22,200	29,600	37,000	44,400	51,800	59,200	66,600	74,000
WIRE ROPE: 5/8" ROTATION RESISTANT COMPACTED STRAND, 18X19 OR 19X19 MINIMUM BREAKING STRENGTH - 22.7 TONS 5/8" 6X19 OR 6X37 IWRC IPS PREFORMED RIGHT REGULAR LAY MINIMUM BREAKING STRENGTH - 17.9 TONS										

RECOMMENDED TIRE PRESSURE

TIRE SIZE	STATIONARY	CREEP	2 1/2 MPH	TRAVEL
21:00 X 25-28 PR	85 PSI	85 PSI	85 PSI	65 PSI
26:50 X 25-26 PR	65 PSI	65 PSI	65 PSI	50 PSI

GENERAL NOTES

GENERAL

1. Rated loads as shown on Lift Charts pertain to this machine as originally manufactured and equipped. Modifications to the machine or use of optional equipment other than that specified can result in a reduction of capacity.
2. Construction equipment can be hazardous if improperly operated or maintained. Operation and maintenance of this machine shall be in compliance with the information in the Operator's, Parts and Safety Manuals supplied with this machine. If these manuals are missing, order replacements from the manufacturer through your distributor.
3. These warnings do not constitute all of the operating conditions for the crane. The operator and job site supervision must read the OPERATORS MANUAL, CIMA SAFETY MANUAL, APPLICABLE OSHA REGULATIONS, AND SOCIETY OF MECHANICAL ENGINEERS (ASME) SAFETY STANDARDS FOR CRANES.
4. This crane and its load ratings are in accordance with POWER CRANE & SHOVEL ASSOCIATION, STANDARD NO. 4, SAE CRANE LOAD STABILITY TEST CODE J765A, SAE METHOD OF TEST FOR CRANE STRUCTURE J1063 AND APPLICABLE SAFETY CODE FOR CRANES, DERRICKS AND HOISTS, ASME/ANSI B30.5.

DEFINITIONS

1. **LOAD RADIUS** – The horizontal distance from the axis of rotation before loading to the center of the vertical hoist line or tackle with a load applied.
2. **LOADED BOOM ANGLE** – It is the angle between the boom base section and the horizontal, after lifting the rated load at the rated radius. The boom angle before loading should be greater to account for deflections. The loaded boom angle combined with boom length give only an approximation of the operating radius.
3. **WORKING AREA** – Areas measured in a circular arc about the centerline of rotation as shown in the diagram.
4. **FREELY SUSPENDED LOAD** – Load hanging free with no direct external force applied except by the hoist rope.
5. **SIDE LOAD** – Horizontal force applied to the lifted load either on the ground or in the air.
6. **NO LOAD STABILITY LIMIT** – The stability limit radius shown on the range diagrams is the radius beyond which it is not permitted to position the boom, when the boom angle is less than the minimum shown on the applicable load chart, because the machine can overturn without any load.

SET-UP

1. Crane load ratings are based on the crane being leveled and standing on a firm, uniform supporting surface.
2. Crane load ratings on outriggers are based on all outrigger beams being fully extended or in the case of partial extension ratings mechanically pinned in the appropriate position, and the tires free of the supporting surface.
3. Crane load ratings on tires depend on appropriate inflation pressure and the tire conditions. Caution must be exercised when increasing air pressures in tires. Consult Operator's Manual for precautions.
4. Use of jibs, lattice-type boom extensions, or fourth section pullouts extended is not permitted for pick and carry operations.
5. Consult appropriate section of the Operator's and Service Manual for more exact description of hoist line reeving.
6. The use of more parts of line than required by the load may result in having insufficient rope to allow the hook block to reach the ground.
7. Properly maintained wire rope is essential for safe crane operation. Consult Operator's Manual for proper maintenance and inspection requirements.

8. When spin-resistant wire rope is used, the allowable rope loading shall be the breaking strength divided by five (5), unless otherwise specified by the wire rope manufacturer.

OPERATION

1. **CRANE LOAD RATINGS MUST NOT BE EXCEEDED. DO NOT ATTEMPT TO TIP THE CRANE TO DETERMINE ALLOWABLE LOADS.**
2. When either radius or boom length, or both, are between listed values, the smaller of the two listed load ratings shall be used.
3. Do not operate at longer radii than those listed on the applicable load rating chart (cross hatched areas shown on range diagrams).
4. The boom angles shown on the Capacity Chart give an approximation of the operating radius for a specified boom length. The boom angle, before loading, should be greater to account for boom deflection. It may be necessary to retract the boom if maximum boom angle is insufficient to maintain rated radius.
5. Power telescoping boom sections must be extended equally.
6. Rated loads include the weight of hook block, slings, and auxiliary lifting devices. Their weights shall be subtracted from the listed rated load to obtain the net load that can be lifted.
When lifting over the jib the weight of any hook block, slings, and auxiliary lifting devices at the boom head must be added to the load.
When jibs are erected but unused add two (2) times the weight of any hook block, slings, and auxiliary lifting devices at the jib head to the load.
7. Rated loads do not exceed 85% on outriggers or 75% on tires, of the tipping load as determined by SAE Crane Stability Test Code J765a. Rated loads for partially extended outriggers are determined from the formula, Rated Load = (Tipping Load – 0.1 X Tip Reaction) / 1.25. Structural strength ratings in chart are indicated with an asterisk (*).
8. Rated loads are based on freely suspended loads. No attempt shall be made to drag a load horizontally on the ground in any direction.
9. The user shall operate at reduced ratings to allow for adverse job conditions, such as: Soft or uneven ground, out of level conditions, high winds, side loads, pendulum action, jerking or sudden stopping of loads, hazardous conditions, experience of personnel, two machine lifts, traveling with loads, electric wires, etc., (side pull on boom or jib is hazardous). Derating of the cranes lifting capacity is required when wind speed exceeds 20 MPH. The center of the lifted load must never be allowed to move more than 3" feet off the center line of the base boom section due to the effects of wind, inertia, or any combination of the two.
**Use 2 feet off the center line of the base boom for a two section boom, 3 feet for a three section boom, or 4 feet for a four section boom.
10. The maximum load which can be telescoped is not definable, because of variations in loadings and crane maintenance, but it is permissible to attempt retraction and extension if load ratings are not exceeded.
11. Load ratings are dependent upon the crane being maintained according to manufacturer's specifications.
12. It is recommended that load handling devices, including hooks, and hook blocks, be kept away from boom head at all times.
13. **FOR TRUCK ONLY:** 360° capacities apply only to machines equipped with a front outrigger jack and all five (5) outrigger jacks properly set. If the front (5th) outrigger jack is not properly set, the work area is restricted to the over side and over rear areas as shown on the Crane Working Positions diagram. Use the 360° load ratings in the overside work areas.

WE RESERVE THE RIGHT TO AMEND THESE SPECIFICATIONS AT ANY TIME WITHOUT NOTICE. THE ONLY WARRANTY APPLICABLE IS OUR STANDARD WRITTEN WARRANTY APPLICABLE TO THE PARTICULAR PRODUCT AND SALE. WE MAKE NO OTHER WARRANTY, EXPRESSED OR IMPLIED.

<http://www.terexlift.com>

 **TEREX CRANES**

Waverly, Iowa

TEREX CRANES, INC.
106 12th Street S.E. • Waverly, IA 50677-9466 USA
(319) 352-3920 • FAX: (319) 352-5727